

IC 35



FROZEN DICE



Self-contained ice maker - Sprayer system
Daily production up to 25 kg

• Position n°



• Application fields

Hotel	●●●●●●●●●●	Fish market	●●●●●●●●●●
Restaurant	●●●●●●●●●●	Supermarket	●●●●●●●●●●
Fast food	●●●●●●●●●●	SPA	●●●●●●●●●●
Bar	●●●●●●●●●●	Medical	●●●●●●●●●●
Disco	●●●●●●●●●●	Industry	●●●●●●●●●●

• Features & Plus

- Full cube, compact and crystalline
- Ideal for built-in
- External structure AISI 304 Scotch Brite
- Insulated retractable door
- Electromechanical functioning
- Internal bin insulation HCFC free
- Easy cleaning thanks to rounded surfaces
- ON-OFF switch
- Cleanable antiscaling filter
- Conformity to RoHS directive
- Standard and special voltages
- Model in Tropical Class + 43 ° C
- Undercounter model

• Available dice size

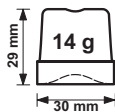

• Prod. 24h

Air temp.	Water temp.	Prod. 24h kg
10° C	10° C	25
21° C	15° C	22
32° C	21° C	18

2 Years Warranty

subject to limitations

• Certifications available for this model



www.ntfice.it
info@ntfice.it



ntfice.it



IC 35



FROZEN DICE



Self-contained ice maker - Sprayer system
Daily production up to 25 kg

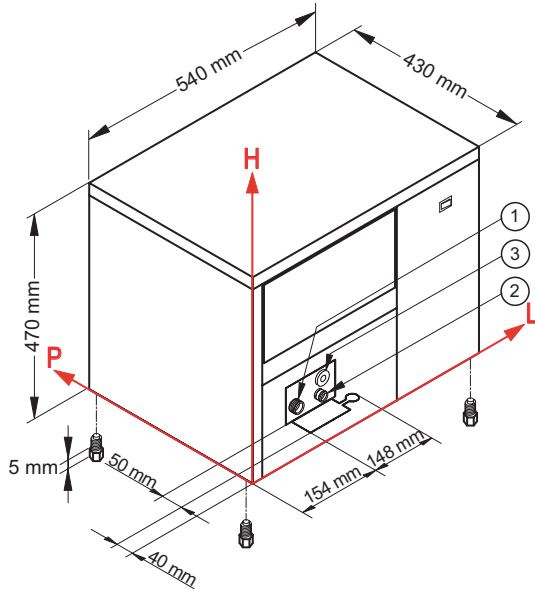

● Connections

- ① Water inlet \varnothing : 3/4"
- ② Water outlet \varnothing : 24 mm
- ③ Electrical connection

● Working conditions





- Location: Indoor

	Min	Max
Ambient temperature	+10° C	+43° C
Water temperature	+3° C	+32° C
Voltage	-10%	+10%
Water inlet pressure	1bar (14 psi)	6bar (84 psi)

● Technical information

Production in 24h	22 kg
Store capacity, up to	4 kg
Cooling system	A
Kind of cube	14 g
Refrigerant	R404A - R452A
Standard voltage	220-240 V ~ 50 Hz
Electrical consumption	320 W
Fuse	10 A
Water consumption	4,5 l/kg
Sizes (L-P-H mm)	540 - 430 - 470
Sizes with pack (L-P-H mm)	590 - 490 - 640
Net weight	34 kg
Gross weight	39 kg
Finish	AISI 304 stainless steel, scotch brite

All the technical information must be considered at the following conditions:

				
Sizes without feet	Standard Cube (14 g)	Ambient temperature +21° C	Water temperature +15° C	Electrical consumption at +43° C (standard voltage)
Refrigerant R404A				

Models and specifications are subject to change without notice
Rev. 01 - Issued May 2018



www.ntfice.it
info@ntfice.it



ntfice.it

